

KNX-Mallia Senses command 4/6/8 push

**Cat.No(s): 281024MW/DS/BB
 281025MW/DS/BB
 281026MW/DS/BB**

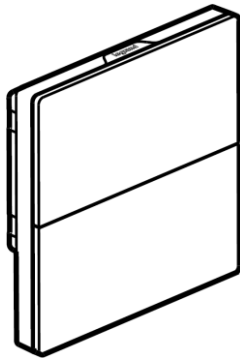

281024MW/DS/BB

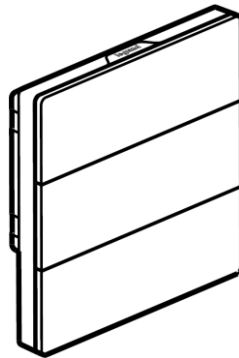

281025MW/DS/BB

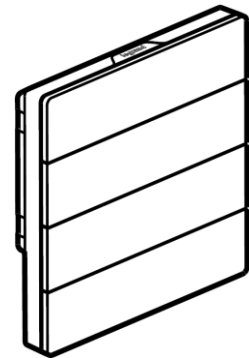

281026MW/DS/BB

1. SUMMARY	3
2. TECHNICAL SPECIFICATINS AND DIMENSIONS, WIRING DIAGRAM	4
2.1. TECHNICAL PARAMETERS	4
2.2. DIMENSION AND WIRING DIAGRAM	5
2.2.1. Dimensional drawing	5
2.2.2. Wiring diagram	5
2.3. INSTALLATION	5
2.3.1. Installation	5
3. PARAMETER SETTING DESCRIPTION IN ETS	6
3.1. SUMMARY	6
3.2. GENERAL > GENERAL SETTING	6
3.3. GENERAL > PROXIMITY SETTING	6
3.4. BUTTON > BUTTON SETTING	7
3.5. BUTTON > BUTTON X	7
3.5.1. Parameter setting interface "Disable"	8
3.5.2. Parameter setting interface "Switch"	8
3.5.3. Parameter setting interface "Dimming"	8
3.5.4. Parameter setting interface "Blind"	9
3.5.5. Parameter setting interface "Value output"	9
3.5.6. Parameter setting interface "Scene control"	10
3.6. PARAMETER SETTING INTERFACE "BUTTON > LED FUNCTION"	11
3.7. PARAMETER SETTING INTERFACE "INTERNAL SENSOR > MEASUREMENT SETTING"	11
4. COMMUNICATION OBJECT	13
4.1. "GENERAL" COMMUNICATION OBJECT	13
4.2. "PROXIMITY FUNCTION" COMMUNICATION OBJECT	13
4.3. "BUTTON X- SWITCH" COMMUNICATION OBJECTS	14
4.4. "BUTTON X-DIMMING" COMMUNICATION OBJECTS	15
4.5. "BUTTON X-BLIND" COMMUNICATION OBJECT	16

4.6. "BUTTON X-VALUE OUTPUT" COMMUNICATION OBJECTS17
4.7. "BUTTON X-SCENE CONTROL" COMMUNICATION OBJECT18
4.8. "LED X" COMMUNICATION OBJECTS19
4.9. "INTERNAL SENSOR" COMMUNICATION OBJECT19

1. SUMMARY

KNX-Mallia Senses command push series product is mainly used in the building control system, wall-mounted installation, which can be mounted on a conventional 86 junction boxes. These products are used to control a variety of KNX devices, by common button on the device to perform the preset function. Such as sending switch command, scene command, blind, control other devices on the bus.

This manual provides users with detailed technical information about the panel, including installation and programming details, and explains how to use the key panel in connection with practical examples.

KNX-Mallia Senses command push series product powered from KNX bus and need a 24-30V DC auxiliary supply voltage. It is available to assign the physical address and configure the parameters by engineering design tools ETS with knxprod file(support edition ETS5.7 or higher).

The main function of KNX-Mallia Senses command push series product is shown as below:

- Common button functions:
 - Switch
 - Dimming
 - Blind
 - Value output
 - Scene control
- The dual color LED indicator light of the button.
 - Cool white
 - Warm white
- Proximity sensing, screen brightness adjustment.

2. TECHNICAL SPECIFICATIONS AND DIMENSIONS, WIRING DIAGRAM

■ 2.1. Technical parameters

Voltage	KNX	21-30VDC, obtained via the KNX bus		
	Auxiliary	24-30VDC		
Current (Consumption max)	Reference	KNX (mA)	Auxiliary (mA)	Total (mA)
	281024MW/DS/BB	4	17	21
	281025MW/DS/BB	4	20	24
	281026MW/DS/BB	4	24	28
Power consumption (Consumption max)	Reference	KNX (W)	Auxiliary (W)	Total (W)
	281024MW/DS/BB	0.12	0.51	0.63
	281025MW/DS/BB	0.12	0.6	0.72
	281026MW/DS/BB	0.12	0.72	0.84
The connection	KNX	Bus connection terminal (diameter 0.8mm)		
	Auxiliary	Auxiliary connection terminal (diameter 0.8mm)		
Operation and instructions	Red LED and keys	Assign physical address		
	Each switch corresponds to one LED indicator, two indicator colors			
Number of key operations	>20000			
Temperature range	Operation	-5°C... +45°C		
	Storage	-25°C... +55°C		
	Transport	-25°C... +70°C		
Environmental conditions	Humidity	<93%, except for condensation		
Proximity sensing distance	30 cm Note: Proximity sensing is based on microwave technology, The proximity sensing distance is affected by the volume and movement speed of the sensing object, and the distance may become shorter or longer. If the usage environment is not suitable or this function is not needed, please disable proximity sensing function. 281024BB, 281025BB, 281026BB No proximity sensing function.			
The installation	Wall mount, first install the iron sheet bracket on the 86 boxes, then install the panel on the iron sheet bracket.			
Color	White, Silver and Brushed black totally 3 color available. MW: White DS: Silver BB: Brushed black			
Size	86mm×86mm×36.1mm			
Weight	0.125Kg			
Certification	Meet CE and KNX standards			

2. TECHNICAL SPECIFICATINS AND DIMENSIONS, WIRING

DIAGRAM (continues)

■ 2.2. Dimension and wiring diagram

■ 2.2.1. Dimensional drawing

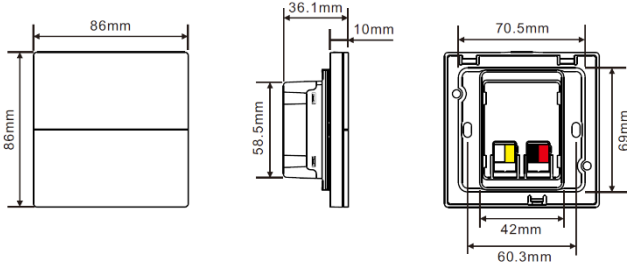

■ 2.2.2. Wiring diagram

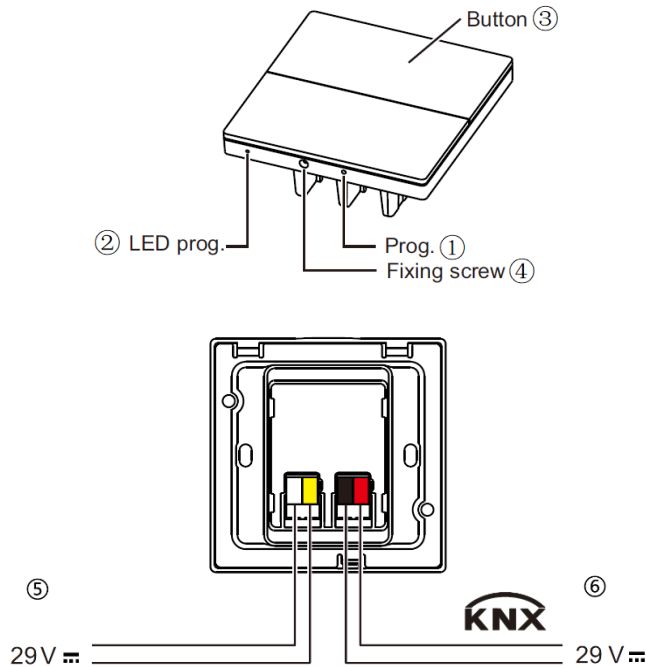

- ① Program buttons
- ② The red LED indicates entering the physical address programming state, and the green LED blinking indicates that the device application layer is working properly
- ③ Smart panel keys
- ④ Mounting screw holes
- ⑤ Auxiliary power supply connection terminals
- ⑥ KNX bus connection terminal

2. TECHNICAL SPECIFICATINS AND DIMENSIONS, WIRING

DIAGRAM (continues)

■ 2.3. Installation

■ 2.3.1. Installation

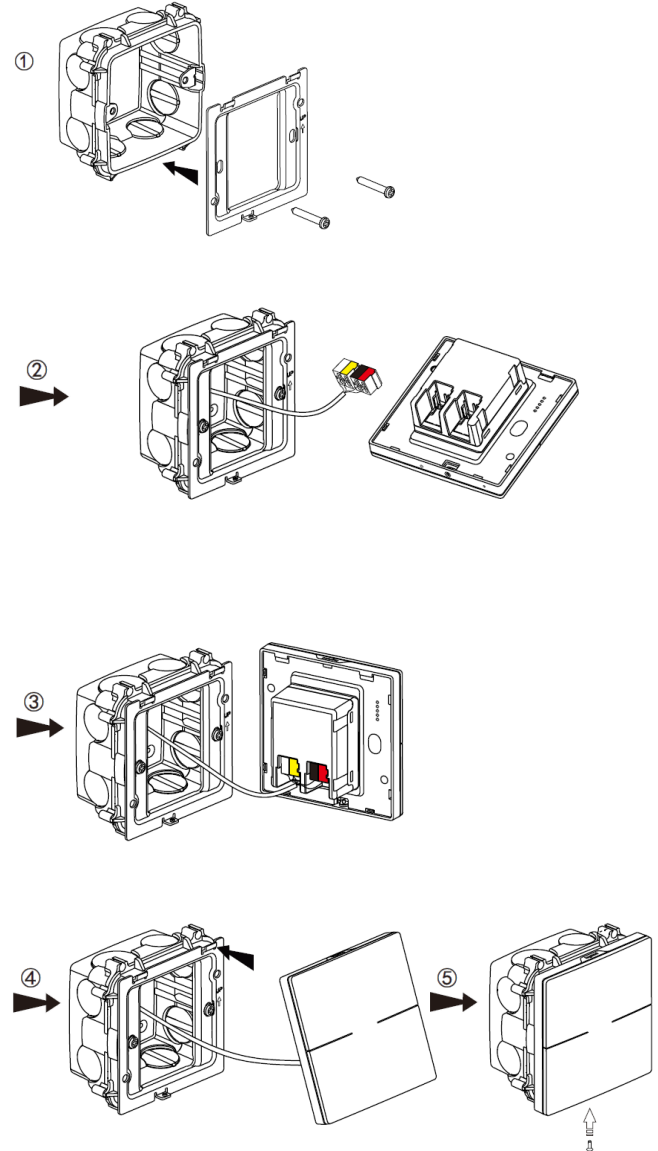

3. PARAMETER SETTING DESCRIPTION IN ETS

■ 3.1. Summary

General Features

General features include backlight Settings for normal or standby working mode, press or touch volume Settings, proximity sensing function Settings, etc.

Switch

This application is used for switch lighting, such as actuators, dimmers, etc. You can send a switch command by operating the switch button,

Switch/dimmer

This application is used for dimming lighting, distinguishing between long press and short press operation, two dimming modes are available, start and stop dimming and step dimming. Through this application, when operating the button of the switch, short press can send a switch command, long press can send a dimming command.

Blinds control

This application is used to trigger blinds or blackout curtains to move or adjust, distinguishing between long press and short press operation, sending different commands, such as: Switch short press operation sends a move command, long press operation sends an adjust or stop command.

Value Output

This application is used to send different values, the types of values are Options: 1bit,4bit,1byte,2byte, operation switch to send, each key can be set by short press and long press to send different values.

Scenario Control

Through this application, you can trigger or save the scene, such as: switch short press operation to activate scene, long press operation to save scene.

LED function

LED features are used for status indication or function indication. At the same time, it can indicate in different colors.

■ 3.2. General> General setting

The "General setting" parameter setting interface shown as Figure 3.1

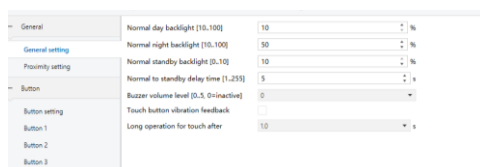

Figure 3.1 "General> General setting" parameter setting interface.

3. PARAMETER SETTING DESCRIPTION IN ETS (continues)

Parameter "Normal day backlight [10..100] "

This parameter for setting the screen backlight brightness of the day.

Options: 10..100

Parameter "Normal night backlight [10..100] "

This parameter for setting the screen backlight brightness at night.

Options: 10..100

Parameter "Normal standby backlight [0..10] "

This parameter for setting standby screen backlight brightness.

Options: 0..10

Parameter "Normal to standby delay time [0..255,0=inactive]"

This parameter for setting the delay time to enter the standby mode of screen

Options: 0...255,0=inactive

Parameter "Buzzer volume level [0..5, 0=inactive] "

This parameter for setting the volume of touch.

Options: 0...5, 0=inactive

Parameter "Touch button vibration feedback"

For setting whether to enable vibration feedback when touched.

Parameter "Long operation for touch after"

Defines long operation time

Options:

0.5

1.0

2.0

3.0

■ 3.3. General> Proximity setting

The Proximity setting interface shown as Figure 3.2. On the Proximity setting interface, you can configure the proximity Setting for the device.

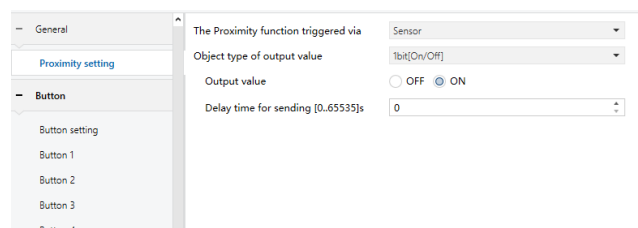

Figure 3.2 The "General>Proximity setting" parameter setting interface.

3. PARAMETER SETTING DESCRIPTION IN ETS (continues)

Parameter "The Proximity function triggered via"

Setting for screen wake up mode.

Options:

- Disable
- Sensor
- Proximity object
- Sensor or Proximity object

Note: 281027BB, 281028BB, 281029BB These three devices not have this funtion.

Parameter "Object type output value":

For setting the object type of output value to the bus when proximity approaching.

Options:

- No reaction
- 1bit(On/Off)
- 1byte(sence control)

When parameter "Object type output value" set as "1bit(On/Off)" or "1byte(sence control)", set next parameter

Parameter "Output value"

The "Object type output value" parameter jointly determines the value of the Proximity output of an object.

When parameter "Object type output value" set as 1bit(On/Off)

Options:

- OFF
- ON

When parameter "Object type output value" set as "1byte(sence-control) "

Options:

- Sense NO.1: Output value "1"
- Sense NO.2: Output value "2"
- ...
- Sense NO.63: Output value "63"
- Sense NO.64: Output value "64"

parameter " Delay time for sending [0..65535]"

This parameter setting the delay time for sending telegram.

Options: 0...255

3.4. Button > Button setting

The parameter setting interface of "Button setting" shown as Figure 3.3. The settings of this screen are applied to all keys of the device. In the introduction below, "Button X" means the one key button of the device. Each button on the device has the same parameter setting interface and

3. PARAMETER SETTING DESCRIPTION IN ETS (continues)

communication object.

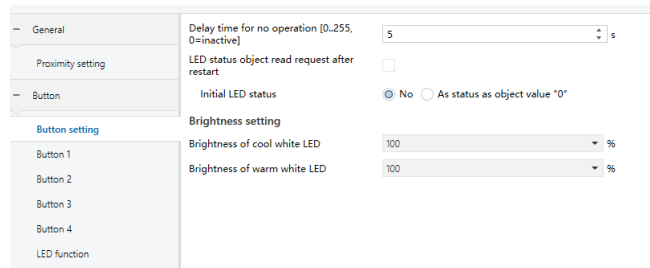

Figure 3.3 "Button setting" parameter setting interface.

Parameter "Delay time for no operation [0..255, 0=inactive]"

Setting the delay time to enter the standby mode of button.

Options: 0...255, 0=inactive

Parameter " LED status object read request after restart"

Setting whether to read LED status after device restart. If not need to read. Set next parameter.

Parameter "Initial LED status"

Setting the Initial LED status.

Options:

- NO
- As status as object value "0"

Brightness setting

Parameter " Brightness of cool white LED"

Parameter " Brightness of warm white LED"

These two parameters for Setting the Brightness of LED.

Options:

- 0
- 10
- 20
- ...
- 100

3.5. Button > Button X

Parameter window " Button X" shown as Figure 3.4, it is mainly for setting specific parameters of button. The setting interface of all button is the same.

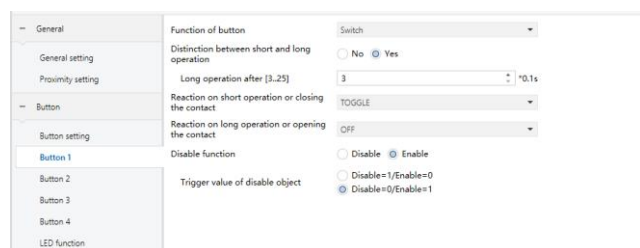

Figure 3.4 "Button X" parameter setting interface

3. PARAMETER SETTING DESCRIPTION IN ETS (continues)

Parameter "Function of button"

Setting function of button X

Options:

- Disable
- Switch
- Dimming
- Blind
- Value output
- Scene control

3.5.1. Parameter setting interface "Disable"



Figure 3.5 "Button X-Disable" parameter setting interface

When the parameter "Function of button" selection set as "Disable", the "Disable" setting interface shown as Figure 3.5 will appear, with the key button set to no function.

3.5.2. Parameter setting interface "Switch"

When the parameter "Function of button" set as "Switch", the "Button X-Switch" parameter setting interface is visible shown as Figure 3.6

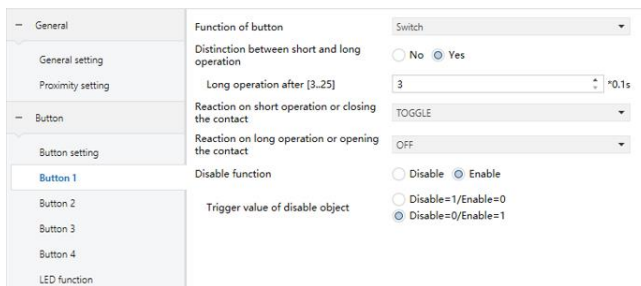

Figure 3.6 "Button X-Switch" parameter setting interface.

Parameter "Distinction between short and long operation"

Setting whether to distinguish between short and long operation.

Options:

- No
- YES

When parameter "Distinction between short and long operation" set as "YES", set next parameter.

3. PARAMETER SETTING DESCRIPTION IN ETS (continues)

Parameter "Long operation after [3..25]"

Setting for how long to press button is defined as a long operation.

Options: 3...25

Parameter "Reaction on short operation or closing the contact"

Parameter "Reaction on long operation or opening the contact"

These two parameters are setting the reaction of button operation for switch.

Options:

- No action
- ON
- OFF
- TOGGLE

Parameter "Disable function"

Setting whether to enable or disable switch function of button through object.

If enable set next parameter.

Parameter "Trigger value of disable object"

Setting to disable switch function of button.

Options:

- Disable=1/Enable=0
- Disable=0/Enable=1

3.5.3. Parameter setting interface "Dimming"

When the parameter "Function of button" selection set as "Dimming", set the relative parameter of "Dimming" on the "Button X- Dimming" parameter setting interface shown as Figure 3.7

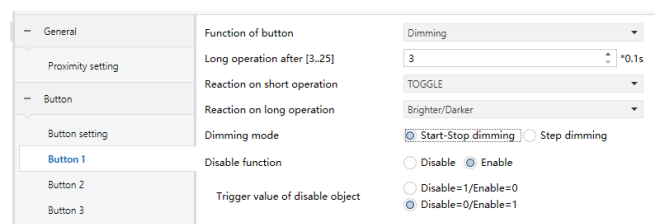

Figure 3.7 "Button X- Dimming" Parameter setting interface

Parameter "Long operation after [3..25]"

Setting for how long to press button is defined as a long operation.

Options: 3...25

3. PARAMETER SETTING DESCRIPTION IN ETS (continues)

Parameter“ Reaction on short operation”

Setting the reaction of button short operation

Options:

- No action
- ON
- OFF
- TOGGLE

Parameter“ Reaction on long operation”

Setting the reaction of button long operation

Options:

- No action
- Brighter
- Darker
- Brighter/darker

Parameter “Dimming mode”

Setting the dimming mode.

Options:

- Start-stop dimming
- Step dimming

When Parameter “Dimming mode” set as “Step dimming”, set next two parameters.

Parameter “Step size”

Setting the step value of. Step dimming

Options:

- | | |
|------|------|
| 1/1 | 100% |
| 1/2 | 50% |
| 1/4 | 25% |
| 1/8 | 12% |
| 1/16 | 6% |
| 1/32 | 3% |
| 1/64 | 1% |

Parameter “Interval of tele. cyclic send [0..25,0-send once]”

Setting the time for cyclical sending telegram in step dimming mode when long operation

Options: 0...25, 0-send once

■ 3.5.4. Parameter setting interface “Blind”

When the parameter "Function of button" selection set as “Blind”, set the relative parameter of " Blind "on the “Button X- Blind " parameter setting interface shown as Figure 3.8

3. PARAMETER SETTING DESCRIPTION IN ETS (continues)

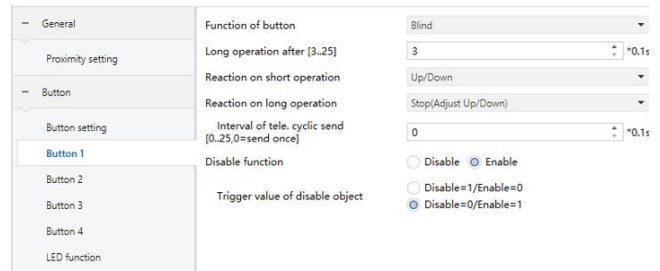

Figure 3.8“Button X- Blind “Parameter setting interface

Parameter“ Long operation after [3..25]”

Setting for how long to press button is defined as a long operation.

Options: 3...25

Parameter“ Reaction on short operation”

Setting the reaction of button short operation

Options:

- No action
- Up
- Down
- Up/Down

Parameter“ Reaction on long operation”

Setting the reaction of button long operation

Options:

- No reaction
- Up
- Down
- Up/Down
- Stop(Adjust Up)
- Stop(Adjust Down)
- Stop(Adjust Up/Down)

Parameter “Interval of tele. cyclic send [0..25,0-send once]) ”

Setting the time for cyclical sending telegram of blind function when long operation

Options: 0...25, 0-send once.

■ 3.5.5. Parameter setting interface “Value output”

When the parameter "Function of button" selection set as “Value output”, set the relative parameter of " Value output "on the “Button X- Value output " parameter setting interface shown as Figure 3.9

3. PARAMETER SETTING DESCRIPTION IN ETS (continues)

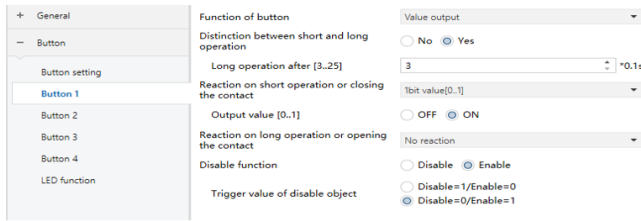

Figure 3.9"Button X- Value output "Parameter setting interface.

Parameter "Distinction between short and long operation"

Setting whether to distinguish between short and long operation.

Options:

- No
- YES

When parameter "Distinction between short and long operation" set as "YES", set next parameter.

Parameter "Long operation after [3..25]"

Setting for how long to press button is defined as a long operation.

Options: 3...25

Parameter "Reaction on short operation or closing the contact"

Parameter "Reaction on long operation or closing the contact"

These two parameters are setting the output value of button operation for value output.

Options:

- No reaction
- 1bit value[0..1]
- 4bit value [0..15]
- 1byte value[0..255]
- 2byte value[0..65535]

Parameter "Output value [0..1]"

Parameter "Output value [0..15] "

Parameter "Output value [0..255] "

Parameter "Output value [0..65535] "

Setting the output value for parameter "Reaction on short operation or closing the contact" and parameter "Reaction on long operation or closing the contact".

3. PARAMETER SETTING DESCRIPTION IN ETS (continues)

Options:

- 0...1
- 0...15
- 0...255
- 0...65535

3.5.6. Parameter setting interface "Scene control"

When the parameter "Function of button" selection set as "Scene control", set the relative parameter of "Scene control" on the "Button X- Scene control " parameter setting interface shown as

Figure 3.10.

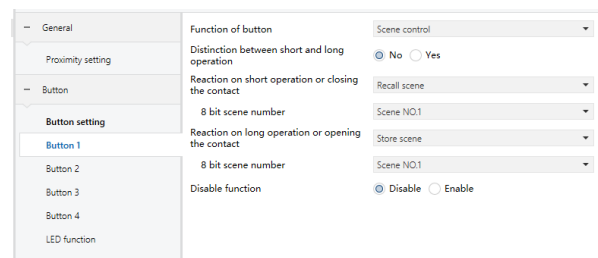

Figure 3.10"Button X-Scene control "Parameter setting interface

Parameter "Distinction between short and long operation"

Setting whether to distinguish between short and long operation.

Options:

- No
- YES

When parameter "Distinction between short and long operation" set as "YES", set next parameter.

Parameter "Long operation after [3..25]"

Setting for how long to press button is defined as a long operation.

Options: 3...25

Parameter "Reaction on short operation or closing the contact"

Parameter "Reaction on long operation or closing the contact"

These two parameters are setting the reaction of button operation for scene control.

Options:

- No reaction
- Recall scene
- Store scene

3. PARAMETER SETTING DESCRIPTION IN ETS (continues)

Parameter "8 bit scene number."

Setting the scene number.

Options:

- Scene NO.1
- Scene NO.2
- Scene NO.3
- ...
- Scene NO.6
- Scene NO.7
- Scene NO.8

3.6. Parameter setting interface "Button > LED function"

Parameter window "Button > LED function" shown as Fig.3.11, it is mainly for setting related parameters of LED function.

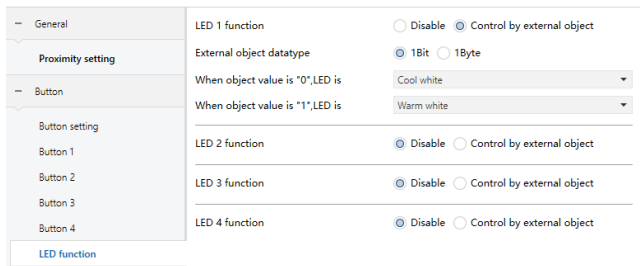

Figure 3.11 Button > LED function Parameter setting interface

Parameter "LED X function"

Setting whether enable the LED indicator function.

Options:

- Disable
- Control by external object

Parameter "External object datatype"

This parameter setting the datatype of external object.

Options:

- 1Bit
- 1Byte

When parameter "External object datatype" set as "1Bit",set the next two parameters

Parameter "When object value is "0",LED is"

Setting the LED indication status after receive telegram "0" from bus.

Options:

- OFF
- Warm white
- Cool white

3. PARAMETER SETTING DESCRIPTION IN ETS (continues)

Parameter "When object value is "1",LED is"

Setting the LED indication status after receive telegram "0" from bus.

Options:

- OFF
- Warm white
- Cool whitefour

When parameter "External object datatype" set as "1Byte",set the next four parameter s

Parameter "Threshold value is"

Parameter "If object value < threshold value,LED is"

Parameter "If object value = threshold value,LED is"

Parameter "If object value > threshold value,LED is"

These four parameters setting the threshold value for LED indicate status switcher.

Options:

- OFF
- Warm white
- Cool white

3.7. Parameter setting interface "Internal sensor >

Measurement setting"

Parameter window "Internal sensor > Measurement setting" shown as Fig.3.12, it is mainly for setting related parameters of internal sensor detection, such as temperature.

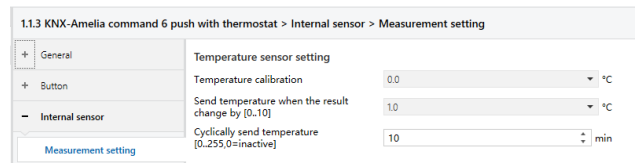

Figure 3.12 Internal sensor > Measurement setting Parameter setting interface

Temperature sensor setting

Parameter "Temperature calibration"

This parameter for setting the temperature calibration value of the internal sensor, that is, to calibrate the measured value of internal sensor to make it closer to the current ambient temperature.

Options:

- 5°C
- ...
- 0°C
- ...
- 5°C

3. PARAMETER SETTING DESCRIPTION IN ETS (continues)

Parameter "Send temperature when the result change by [0..10] "

This parameter for setting when temperature turns to a certain value, send the actual temperature value to the bus.

Options: 1...20

Parameter "Cyclically send temperature [0.255.0-inactive] "

Setting the time for cyclically sending the temperature detection value to the bus.

Options: 0...255min

4. COMMUNICATION OBJECT

The communication object is the medium to communicate other device on the bus, namely only the communication object can communicate with the bus.

NOTE: "C" in "Flag" column in the below table means enable the communication function of the object; "W" means value of object can be written from the bus; "R" means the value of the object can be read by the other devices; "T" means the object has the transmission function; "U" means the value of the object can be updated

■ **4.1. "General" communication object**

	Name ^	Number	Object Function	Group Address	Length	C	R	W	T	U	Data Type	Priority
■	General	36	Day/Night		1 bit	C	-	W	-	-	day/night	Low
■	General	37	Screen locking		1 bit	C	-	W	-	-	enable	Low

Figure 4.1 General Communication object

NO.	Function	Name	Data length	Attribute	Data type DPT
36	Day/Night	General	1bit	C,W	day/night
This communication object is used to receive the status value of day/night status from the bus. Telegram value: Day Night					
37	Screen locking	General	1bit	C,W	enable
This communication object is used to receive telegram value from bus to lock the screen. Telegram value: Disable Enable					

Table 4.1 "General" Communication object table

■ **4.2. "Proximity function" Communication object**

	Name	Number ^	Object Function	Group Address	Length	C	R	W	T	U	Data Type	Priority
■	Proximity function	33	Dis/En Proximity function	5123	1 bit	C	-	W	-	-	enable	Low
■	Proximity function	34	Proximity input	5124	1 bit	C	-	W	-	-	switch	Low
■	Proximity function	35	Proximity output	5126	1 byte	C	-	-	T	-	scene number	Low

Figure 4.2 "Proximity function" communication object

NO.	Function	Name	Data length	Attribute	Data type DPT
33	Dis/En Proximity function	Proximity function	1bit	C, W	enable
This communication object is used to receive telegram value from bus to disable or enable proximity function. Telegram value: Disable Enable					
34	Proximity input	Proximity function	1bit	C, W	switch
This communication object is used to receive the status value of proximity function from the bus. Telegram value: ON OFF					
35	Proximity output	Proximity function	1bit/ 1 byte	C, T	witch scene number

4. COMMUNICATION OBJECT (continues)

This communication object is used to send telegram value to bus after promoting to device.
 The telegram value can be set by parameter " Object type of output value"and " Output value " together.
 Telegram value:
 Disable
 Enable
 Or
 Scene NO.1.....Scene NO.64

Table 4.2 "Proximity function" communication objects

4.3. "Button X- Switch" communication objects

	Name	Number ^	Object Function	Group Address	Length	C	R	W	T	U	Data Type	Priority
■	Button 1	1	Short/Close, Swtich		1 bit	C	-	W	T	-	switch	Low
■	Button 1	2	Long/Open, Swtich		1 bit	C	-	W	T	-	switch	Low
■	Button 1	3	Disable		1 bit	C	-	W	-	-	enable	Low
■	Button 2	4	Short/Close, Swtich		1 bit	C	-	W	T	-	switch	Low
■	Button 2	5	Long/Open, Swtich		1 bit	C	-	W	T	-	switch	Low
■	Button 2	6	Disable		1 bit	C	-	W	-	-	enable	Low
■	Button 3	7	Short/Close, Swtich		1 bit	C	-	W	T	-	switch	Low
■	Button 3	8	Long/Open, Swtich		1 bit	C	-	W	T	-	switch	Low
■	Button 3	9	Disable		1 bit	C	-	W	-	-	enable	Low
■	Button 4	10	Short/Close, Swtich		1 bit	C	-	W	T	-	switch	Low
■	Button 4	11	Long/Open, Swtich		1 bit	C	-	W	T	-	switch	Low
■	Button 4	12	Disable		1 bit	C	-	W	-	-	enable	Low
■	Button 5	13	Short/Close, Swtich		1 bit	C	-	W	T	-	switch	Low
■	Button 5	14	Long/Open, Swtich		1 bit	C	-	W	T	-	switch	Low
■	Button 5	15	Disable		1 bit	C	-	W	-	-	enable	Low
■	Button 6	16	Short/Close, Swtich		1 bit	C	-	W	T	-	switch	Low
■	Button 6	17	Long/Open, Swtich		1 bit	C	-	W	T	-	switch	Low
■	Button 6	18	Disable		1 bit	C	-	W	-	-	enable	Low
■	Button 7	19	Short/Close, Swtich		1 bit	C	-	W	T	-	switch	Low
■	Button 7	20	Long/Open, Swtich		1 bit	C	-	W	T	-	switch	Low
■	Button 7	21	Disable		1 bit	C	-	W	-	-	enable	Low
■	Button 8	22	Short/Close, Swtich		1 bit	C	-	W	T	-	switch	Low
■	Button 8	23	Long/Open, Swtich		1 bit	C	-	W	T	-	switch	Low
■	Button 8	24	Disable		1 bit	C	-	W	-	-	enable	Low

Figure 4.3 " Button X- Switch " communication object

NO.	Function	Name	Data length	Attribute	Data type DPT
1/4/7/10/13/16/19/22	Short/Close, Switch	Button X	1bit	C, W, T	switch
This communication is used to send telegram value to bus after short press on button. It also can be used to receive telegram value from bus to change Button status. The telegram value can be set by parameter "Reaction on short operation or closing the contact" Telegram value: ON OFF					
2/5/8/11/14/17/20/23	Long/Open, Switch	Button X	1bit	C, W,T	1.001switch
This communication is used to send telegram value to bus after long press on button. It also can be used to receive telegram value from bus to change Button status. The telegram value can be set by the parameter "Reaction on long operation or closing the contact". Telegram value: ON OFF					
3/6/9/12/14/18/21/24	Disable	Button X	1bit	C, W	1.003 enable

4. COMMUNICATION OBJECT (continues)

This communication is used to receive telegram value from bus to enable or disable button function. telegram value is set by the parameter "Trigger value of disable object".

Telegram value:

- Disable
- Enable

Table 4.3" Button X- Switch " communication object

4.4. "Button X-Dimming" communication objects

Name	Number ^	Object Function	Group Address	Length	C	R	W	T	U	Data Type	Priority
Button 1	1	Short, Switch		1 bit	C	-	W	T	-	switch	Low
Button 1	2	Long, Dimming		4 bit	C	-	W	T	-	dimming control	Low
Button 1	3	Disable		1 bit	C	-	W	-	-	enable	Low
Button 2	4	Short, Switch		1 bit	C	-	W	T	-	switch	Low
Button 2	5	Long, Dimming		4 bit	C	-	W	T	-	dimming control	Low
Button 2	6	Disable		1 bit	C	-	W	-	-	enable	Low
Button 3	7	Short, Switch		1 bit	C	-	W	T	-	switch	Low
Button 3	8	Long, Dimming		4 bit	C	-	W	T	-	dimming control	Low
Button 3	9	Disable		1 bit	C	-	W	-	-	enable	Low
Button 4	10	Short, Switch		1 bit	C	-	W	T	-	switch	Low
Button 4	11	Long, Dimming		4 bit	C	-	W	T	-	dimming control	Low
Button 4	12	Disable		1 bit	C	-	W	-	-	enable	Low
Button 5	13	Short, Switch		1 bit	C	-	W	T	-	switch	Low
Button 5	14	Long, Dimming		4 bit	C	-	W	T	-	dimming control	Low
Button 5	15	Disable		1 bit	C	-	W	-	-	enable	Low
Button 6	16	Short, Switch		1 bit	C	-	W	T	-	switch	Low
Button 6	17	Long, Dimming		4 bit	C	-	W	T	-	dimming control	Low
Button 6	18	Disable		1 bit	C	-	W	-	-	enable	Low
Button 7	19	Short, Switch		1 bit	C	-	W	T	-	switch	Low
Button 7	20	Long, Dimming		4 bit	C	-	W	T	-	dimming control	Low
Button 7	21	Disable		1 bit	C	-	W	-	-	enable	Low
Button 8	22	Short, Switch		1 bit	C	-	W	T	-	switch	Low
Button 8	23	Long, Dimming		4 bit	C	-	W	T	-	dimming control	Low
Button 8	24	Disable		1 bit	C	-	W	-	-	enable	Low

Figure 4.4 " Button X-Dimming " communication object

NO.	Function	Name	Data length	Attribute	Data type DPT
1/4/7/10/13/16/19/22	Short, Switch	Button X	1bit	C, W, T	1.001switch
<p>This communication is used to send telegram value to bus after short press on button. It also can be used to receive telegram value from bus to change Button status. The telegram value can be set by parameter "Reaction on short operation or closing the contact." Telegram value: ON OFF</p>					
2/5/8/11/14/17/20/23	Long, Dimming	Button X	4bit	C, W, T	3.007 dimming control
<p>The communication object is used to send telegram value of dimming to bus after long press on button. It also can use for receiving telegram value from bus to change dimming status. The telegram value can be set by parameter "Reaction on long operation or closing the contact." And parameter "Dimming mode." together. Telegram value: Decrease, Break, Decrease, 100 %, Decrease, 50 %...Decrease, 1%, Increase, 1%... Increase, 50 %, Increase, 100 %, Increase, Break</p>					

Table 4.4"Button X-Dimming" communication object

4. COMMUNICATION OBJECT (continues)

■ 4.5. "Button X-Blind" communication object

	Name	Number ^	Object Function	Group Address	Length	C	R	W	T	U	Data Type	Priorit
■	Button 1	1	Up/Down, Blind		1 bit	C	-	-	T	-	up/down	Low
■	Button 1	2	Stop/Adjust, Blind		1 bit	C	-	-	T	-	step	Low
■	Button 1	3	Disable		1 bit	C	-	W	-	-	enable	Low
■	Button 2	4	Up/Down, Blind		1 bit	C	-	-	T	-	up/down	Low
■	Button 2	5	Stop/Adjust, Blind		1 bit	C	-	-	T	-	step	Low
■	Button 2	6	Disable		1 bit	C	-	W	-	-	enable	Low
■	Button 3	7	Up/Down, Blind		1 bit	C	-	-	T	-	up/down	Low
■	Button 3	8	Stop/Adjust, Blind		1 bit	C	-	-	T	-	step	Low
■	Button 3	9	Disable		1 bit	C	-	W	-	-	enable	Low
■	Button 4	10	Up/Down, Blind		1 bit	C	-	-	T	-	up/down	Low
■	Button 4	11	Stop/Adjust, Blind		1 bit	C	-	-	T	-	step	Low
■	Button 4	12	Disable		1 bit	C	-	W	-	-	enable	Low
■	Button 5	13	Up/Down, Blind		1 bit	C	-	-	T	-	up/down	Low
■	Button 5	14	Stop/Adjust, Blind		1 bit	C	-	-	T	-	step	Low
■	Button 5	15	Disable		1 bit	C	-	W	-	-	enable	Low
■	Button 6	16	Up/Down, Blind		1 bit	C	-	-	T	-	up/down	Low
■	Button 6	17	Stop/Adjust, Blind		1 bit	C	-	-	T	-	step	Low
■	Button 6	18	Disable		1 bit	C	-	W	-	-	enable	Low
■	Button 7	19	Up/Down, Blind		1 bit	C	-	-	T	-	up/down	Low
■	Button 7	20	Stop/Adjust, Blind		1 bit	C	-	-	T	-	step	Low
■	Button 7	21	Disable		1 bit	C	-	W	-	-	enable	Low
■	Button 8	22	Up/Down, Blind		1 bit	C	-	-	T	-	up/down	Low
■	Button 8	23	Stop/Adjust, Blind		1 bit	C	-	-	T	-	step	Low
■	Button 8	24	Disable		1 bit	C	-	W	-	-	enable	Low

Figure 4.5 "Button X-Blind" communication object

NO.	Function	Name	Data length	Attribute	Data type DPT
1/4/7/10/13/16/19/22	Up/Down, Blind	Button X	1bit	C, T	up/down
The communication object is used to send telegram value of blind to bus after short press on button. The telegram value can be set by parameter "Reaction on short operation or closing the contact." And parameter "Dimming mode." together. Telegram value: UP Down					
2/5/8/11/14/17/20/23	Stop/Adjust, Blind	Button X	1bit	C, T	step
The communication object is used to send telegram value of blind to bus after long press on button. The telegram value can be set by parameter "Reaction on long operation or closing the contact." And parameter "Dimming mode." together. Telegram value: Decrease Increase					

Table 4.5 "Button X-Blind" communication object

4. COMMUNICATION OBJECT (continues)

■ 4.6. "Button X-Value output" communication objects

	Name	Number ^	Object Function	Group Address	Length	C	R	W	T	U	Data Type	Priority
■	Button 1	1	Short/Close, Value		1 bit	C	-	-	T	-	switch	Low
■	Button 1	2	Long/Open, Value		2 bytes	C	-	-	T	-	pulses	Low
■	Button 1	3	Disable	6146	1 bit	C	-	W	-	-	enable	Low
■	Button 2	4	Short/Close, Value		1 bit	C	-	-	T	-	switch	Low
■	Button 2	5	Long/Open, Value		2 bytes	C	-	-	T	-	pulses	Low
■	Button 2	6	Disable		1 bit	C	-	W	-	-	enable	Low
■	Button 3	7	Short/Close, Value		1 bit	C	-	-	T	-	switch	Low
■	Button 3	8	Long/Open, Value		2 bytes	C	-	-	T	-	pulses	Low
■	Button 3	9	Disable		1 bit	C	-	W	-	-	enable	Low
■	Button 4	10	Short/Close, Value		1 bit	C	-	-	T	-	switch	Low
■	Button 4	11	Long/Open, Value		2 bytes	C	-	-	T	-	pulses	Low
■	Button 4	12	Disable		1 bit	C	-	W	-	-	enable	Low
■	Button 5	13	Short/Close, Value		1 bit	C	-	-	T	-	switch	Low
■	Button 5	14	Long/Open, Value		2 bytes	C	-	-	T	-	pulses	Low
■	Button 5	15	Disable		1 bit	C	-	W	-	-	enable	Low
■	Button 6	16	Short/Close, Value		1 bit	C	-	-	T	-	switch	Low
■	Button 6	17	Long/Open, Value		2 bytes	C	-	-	T	-	pulses	Low
■	Button 6	18	Disable		1 bit	C	-	W	-	-	enable	Low
■	Button 7	19	Short/Close, Value		1 bit	C	-	-	T	-	switch	Low
■	Button 7	20	Long/Open, Value		2 bytes	C	-	-	T	-	pulses	Low
■	Button 7	21	Disable		1 bit	C	-	W	-	-	enable	Low
■	Button 8	22	Short/Close, Value		1 bit	C	-	-	T	-	switch	Low
■	Button 8	23	Long/Open, Value		2 bytes	C	-	-	T	-	pulses	Low
■	Button 8	24	Disable		1 bit	C	-	W	-	-	enable	Low

Figure 4.6. "Button X-Value output" communication objects

NO.	Function	Name	Data length	Attribute	Data type DPT
1/4/7/ 10/13/16/ 19/22	Shor/Close, Value	Button X	1 bit 4 bit 1 byte 2 byte	C, T	switch dimming control counter pulses (0...255) pulses
<p>This communication object is used to send telegram value to bus after short press on button. The telegram value can be set by parameter "Reaction on short operation or closing the contact." And parameter "Output value [0...XX]." together.</p> <p>Telegram value:</p> <p>OFF/ON Or 0...15 Or 0...255 Or 0...65535</p>					
2/5/8/11/ 14/17/20/23	Long/Open, Value	Button X	1 bit 4 bit 1 byte 2 byte	C, T	switch dimming control counter pulses (0...255) pulses
<p>This communication object is used to send telegram value to bus after long press on button. The telegram value can be set by parameter "Reaction on long operation or closing the contact." And parameter "Output value [0...XX]." together.</p> <p>Telegram value:</p> <p>OFF/ON Or 0...15 Or 0...255 Or 0...65535</p>					

Table 4.6. "Button X-Value output" communication objects

4. COMMUNICATION OBJECT (continues)

■ 4.7. "Button X-Scene control" communication object

	Name	Number *	Object Function	Group Address	Length	C	R	W	T	U	Data Type	Priority
■	Button 1	1	Short/Close, Scene		1 byte	C	-	-	T	-	scene number	Low
■	Button 1	2	Long/Open, Scene		1 byte	C	-	-	T	-	scene number	Low
■	Button 1	3	Disable		1 bit	C	-	W	-	-	enable	Low
■	Button 2	4	Short/Close, Scene		1 byte	C	-	-	T	-	scene number	Low
■	Button 2	5	Long/Open, Scene		1 byte	C	-	-	T	-	scene number	Low
■	Button 2	6	Disable		1 bit	C	-	W	-	-	enable	Low
■	Button 3	7	Short/Close, Scene		1 byte	C	-	-	T	-	scene number	Low
■	Button 3	8	Long/Open, Scene		1 byte	C	-	-	T	-	scene number	Low
■	Button 3	9	Disable		1 bit	C	-	W	-	-	enable	Low
■	Button 4	10	Short/Close, Scene		1 byte	C	-	-	T	-	scene number	Low
■	Button 4	11	Long/Open, Scene		1 byte	C	-	-	T	-	scene number	Low
■	Button 4	12	Disable		1 bit	C	-	W	-	-	enable	Low
■	Button 5	13	Short/Close, Scene		1 byte	C	-	-	T	-	scene number	Low
■	Button 5	14	Long/Open, Scene		1 byte	C	-	-	T	-	scene number	Low
■	Button 5	15	Disable		1 bit	C	-	W	-	-	enable	Low
■	Button 6	16	Short/Close, Scene		1 byte	C	-	-	T	-	scene number	Low
■	Button 6	17	Long/Open, Scene		1 byte	C	-	-	T	-	scene number	Low
■	Button 6	18	Disable		1 bit	C	-	W	-	-	enable	Low
■	Button 7	19	Short/Close, Scene		1 byte	C	-	-	T	-	scene number	Low
■	Button 7	20	Long/Open, Scene		1 byte	C	-	-	T	-	scene number	Low
■	Button 7	21	Disable		1 bit	C	-	W	-	-	enable	Low
■	Button 8	22	Short/Close, Scene		1 byte	C	-	-	T	-	scene number	Low
■	Button 8	23	Long/Open, Scene		1 byte	C	-	-	T	-	scene number	Low
■	Button 8	24	Disable		1 bit	C	-	W	-	-	enable	Low

Figure 4.7 "Button X-Scene control" communication object

NO.	Function	Name	Data length	Attribute	Data type DPT
1/4/7/10/13/16/19/22	Short/Close, Scene	Button X	1Byte	C, T	scene number
This communication object is used to send control telegram to recall or store scene NO.X after short press on the button. Telegram value: Scene NO.1 Scene NO.2 ... Scene NO.63 Scene NO.64					
2/5/8/11/14/17/20/23	Long/Open, Scene	Button X	1Byte	C, T	scene number
This communication object is used to send control telegram to recall or store scene NO.X after long press on the button. Telegram value: Scene NO.1 Scene NO. Scene NO.63 Scene NO.64					

Table 4.7 "Button X-Scene control" communication object

4. COMMUNICATION OBJECT (continues)

■ **4.8. "LED X" communication objects**

	Name	Number ^	Object Function	Group Address	Length	C	R	W	T	U	Data Type	Priority
■	LED 1	25	Status		1 bit	C	-	W	T	U	switch	Low
■	LED 2	26	Status		1 bit	C	-	W	T	U	switch	Low
■	LED 3	27	Status		1 bit	C	-	W	T	U	switch	Low
■	LED 4	28	Status		1 bit	C	-	W	T	U	switch	Low
■	LED 5	29	Status		1 bit	C	-	W	T	U	switch	Low
■	LED 6	30	Status		1 bit	C	-	W	T	U	switch	Low
■	LED 7	31	Status		1 bit	C	-	W	T	U	switch	Low
■	LED 8	32	Status		1 bit	C	-	W	T	U	switch	Low

Figure 4.8. "Status" LED status displays the communication object.

NO.	Function	Name	Data length	Attribute	Data type DPT
25/26/27 /28/29/30/31/32	Status	LED X	1bit 1byte	C, W, T, U	switch counter pulses (0..255)

This communication object is used to receive control telegram value of LED status to control led status on device.

It is also used to send telegram value of LED status to bus.

The led status and telegram value are set by parameter "External object datatype.", parameter "When object value is "0",LED is"and parameter "When object value is "1",LED is" together or set by parameter "External object datatype.", parameter "Threshold value is", parameter "If object value<threshold value, LED is", parameter "If object value=threshold value, LED is", and parameter "If object value>threshold value, LED is" together.

Telegram value:

OFF/ON

Or 1...255

Table 4.8. "LED X" communication objects

■ **4.9. "Internal sensor" communication object**

	Name	Number ^	Object Function	Group Address	Length	C	R	W	T	U	Data Type	Priority
■	Internal sensor	38	Temperature value		2 bytes	C	R	-	T	-	temperature (°C)	Low

Figure 4.9 "Internal sensor" communication object

NO.	Function	Name	Data length	Attribute	Data type DPT
38	Temperature value	Internal sensor	2 bytes	C, R,T	temperature (°C)

The communication object is used to send telegram value of temperature detected by the built-in temperature sensor of the device to the bus.

Table 4.9. "Internal sensor" communication objects